

DIGIROCK-R

Digital Rockwell Hardness Tester



CE

BMS Bulut Makina Sanayi ve Ticaret Ltd. Şti.

Kocaeli KOBİ Organize Sanayi Bölgesi
Köseler Mahallesi, 6.Cadde No: 20/2 Dilovası / KOCAELİ / TURKEY

Phone: +90 262 502 97 73-76 / +90 262 503 06 51

web : www.bulutmak.com e-mail : bms@bulutmak.com

1	Technical Specifications.....	3
2	Standard Accessories.....	3
3	Unpacking of Equipment.....	5
4	Setting into Operation.....	5
5	Rockwell Hardness Testing (EN 6508-1, ASTM E18).....	5
6	Test Method.....	7
7	Prior to Test.....	8
8	Choosing the Test Load.....	8
8.1	Main Screen.....	8
9	Testing.....	9
10	Test Method.....	9
11	Records.....	10
12	Settings.....	10
13	Calibration.....	15

1 Technical Specifications

Pre-load (kgf)	10
Test loads (kgf)	60, 100, 150
Load selection	Manual
Test method	Rockwell
Load application	Hydraulic
Max. test height	220 mm
Depth of throat	145 mm
Machine dim's	720x520x280 mm
Case dim's	790x590x420 mm
Weight (net/gross)	82/110 kg

2 Standard Accessories

Rockwell Diamond Indenter: 1

1/16" Ball Indenter: 1

HRC Test Block: 1

HRB Test Block: 1

Flat Testing Table: 1

V Testing Table: 1

Hardness Conversion Table: 1

Case for Accessories: 1

Cover: 1

Allen Spanner: 2

Rubber Bellow for Elevating Screw: 1

Instruction Manual: 1

Calibration Certificate: 1

TABLE FOR HARDNESS TESTER

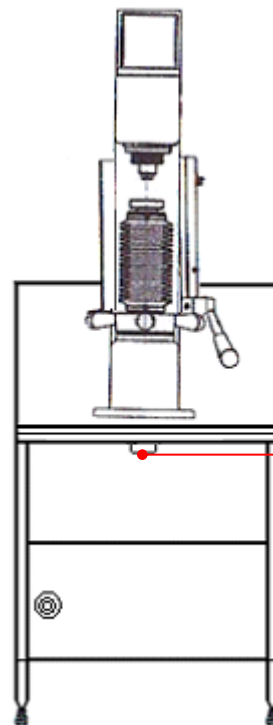
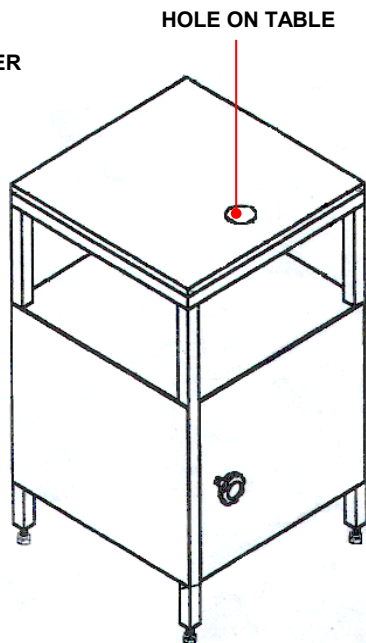

ELEVATING SCREW
MUST FREELY
WORK IN HOLE



Touch screen panel

Top cover

Indenter

Test table

Elevating screw

Rotating arm

Loading arm

3 Unpacking of Equipment

Unscrew fixing steel sheet plates of upper side to wooden base of case and hold up upper side of wooden case by means of carrying handles. Take out two M8 bolts fastening equipment to lower wooden case. Locate equipment on a special table (see drawing of table enclosed) and fasten two M8 bolts by means of eye bull putting on flat testing table.

Open left cover. Take out wooden safety parts. Take out also 3 off M6 bolts of top cover by means of 5 mm special alien key which is in accessory box with care. Take out plastic safety parts. Equipment is now ready for testing.

4 Setting into Operation

Locate part to be tested on testing table, insert indenter to holder and choose load by means of load selector disc (according to testing method in attached table).

For Rockwell tests, HRC, HRA, HRD tests Rockwell Diamond indenter to be chosen while 1/16" ball indenter for HRB, HR, and HRG tests (see enclosed table)

Using 1/8", 1/4", 1/2" ball indenters (optional) others tests can be also archived.

For Rockwell Superficial tests, using Rockwell Diamond indenter, as like HR15N, 30N and 45N can be archived while 1/16" ball indenter for HR15T, 30T and 45T tests.

IMPORTANT: Pre-load selector disc has to be in position HR 10 KG for Rockwell Tests while HSR 3 KG for Rockwell Superficial Tests.

5 Rockwell Hardness Testing (EN 6508-1, ASTM E18)

Rockwell Hardness testing method is evaluated from penetration depth of 120° diamond cone or ball indenter with different dias (please refer to table enclosed) .

Below application shows working procedures using Rockwell diamond cone (HRC-HRA etc.)

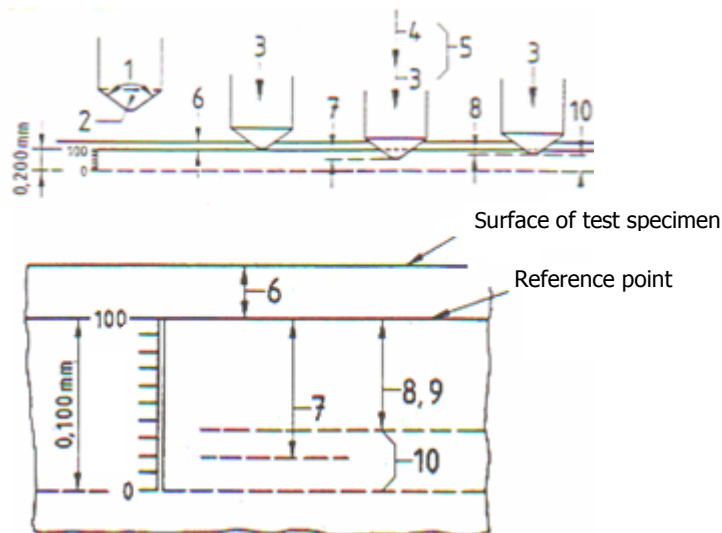

Nr	Symbol	Description
1	0	120 ° Diamond cone
2	0	Radius of diamond tip= 0,2 mm
3	F ₀	Pre-Load
4	F ₁	Additional Load
5	F	Total load F ₀ + F ₁
6	t ₀	Depth of penetration under pre-load, mm
7	t ₁	Depth of penetration under additional load, mm
8	t _b	Increase in depth of penetration from F ₁ to F ₀ , mm
9	e	Equality as of 0,002 mm increase of depth of penetration e= tb / 0,002
10	0	Rockwell hardness = 100-e

Below application shows working procedures using 1/16” ball indenter (HRB etc.)

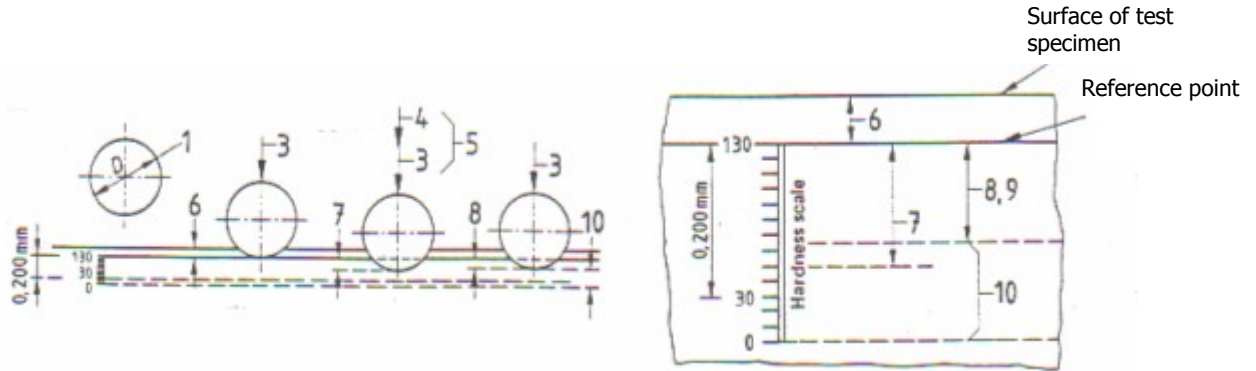

No	Symbol	Description
1	D	Ball dia=1/16 “ =1,5875 mm
3	F ₀	Pre-load
4	F ₁	Additional load
5	F	Total load =F ₀ +F ₁
6	t ₀	Depth of penetration under pre-load, mm
7	t ₁	Depth of penetration under additional load, mm
8	t _b	Increase in depth of penetration from F ₁ to F ₀ , mm
9	e	Equality as of 0,002 mm increase of depth of penetration e= tb / 0,002
10	HRB/HRF	Rockwell hardness= 130-e

6 Test Method

Test method	Indenter	Pre-load (kgf)	Total load (kgf)	Field of application
HRA	Diamond cone	10	60	Surface hardened parts with thin cases ($\geq 0,4$ mm)
HRB	1/16" ball	10	100	Nonferrous metals, unhardened steels
HRC	Diamond cone	10	150	Hardened steels
HRD	Diamond cone	10	100	Surface hardened parts with medium cases
HRE	1/8" ball	10	100	Aluminum and magnesium alloys, antifricition metals, syndetic metals
HRF	1/16" ball	10	60	Annealed cupper alloys, thin sheet metals ($\geq 0,6$ mm)
HRG	1/16" ball	10	150	Phosphor-bronze, malleable iron of medium hardness
HRH	1/8" ball	10	60	Aluminum, zinc, lead, grinding stones
HRK	1/8" ball	10	150	Antifricition and other metals of very low hardness
HRL	1/4" ball	10	60	As HRK and hard rubber
HRM	1/4" ball	10	100	As HRK and HRL, laminated wood
HRP	1/4" ball	10	150	HRK, HRL or HRM and synthetic materials
HRR	1/2" ball	10	60	
HRS	1/2" ball	10	100	
HRV	1/2" ball	10	150	As HRK, HRL, HRM, HRP, HRR or HRS

7 Prior to Test

Using table, choose suitable indenter according to test method to be applied. Locate indenter on holder carefully and gently tighten alien screw using alien key.

8 Choosing the Test Load

Choose suitable Rockwell test load according to table 2 using load selector disc. Locate part to be tested on testing anvil.

8.1 Main Screen

CONNECTING TO THE COMPUTER OR PRINTER

SIGN FOR LOWER AND UPPER TOLERANS LIMITS

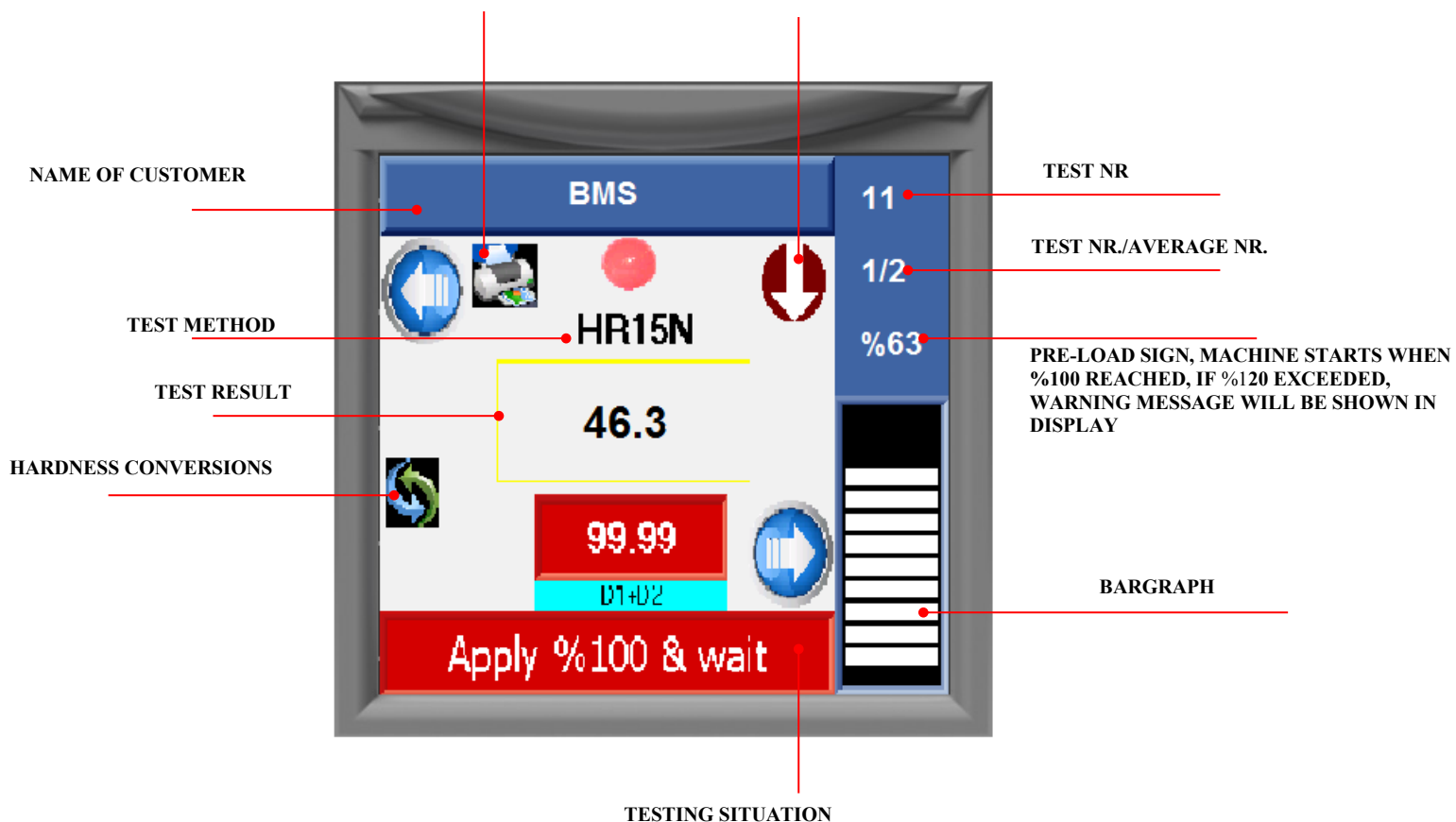



9 Testing

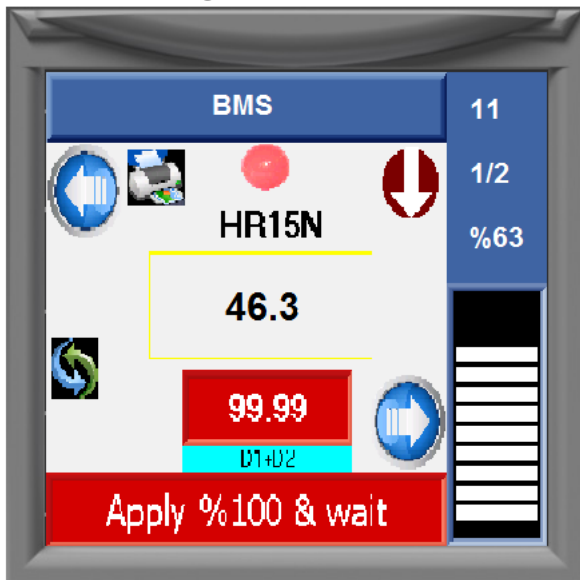

Switch on equipment by ON/ OFF button.

Apply pre-load carefully and follow movement of bargraph until it comes to final position. As soon as pre-load position is reached %100 position, automatic load application will start. When it is over, unloading will start automatically & machine will come back to pre-load position. Then, value will be shown on the screen.

10 Test Method



Choose required test method from TEST METHOD menu.

Apply pre-load until bargraph reaches %100 using rotating arms of elevating spindle. When pre-load application is completed, total load loading, dwelling & unloading will be actuated automatically by motorized system

11 Records

RECORDS section, **registration number, name, min, max, mean, standard deviation**, can be seen. Stored values in the memory can be transferred to micro printer or computer.

NOTE: The total memory capacity ,along with 50 separete entries of 100 datas is 5000.

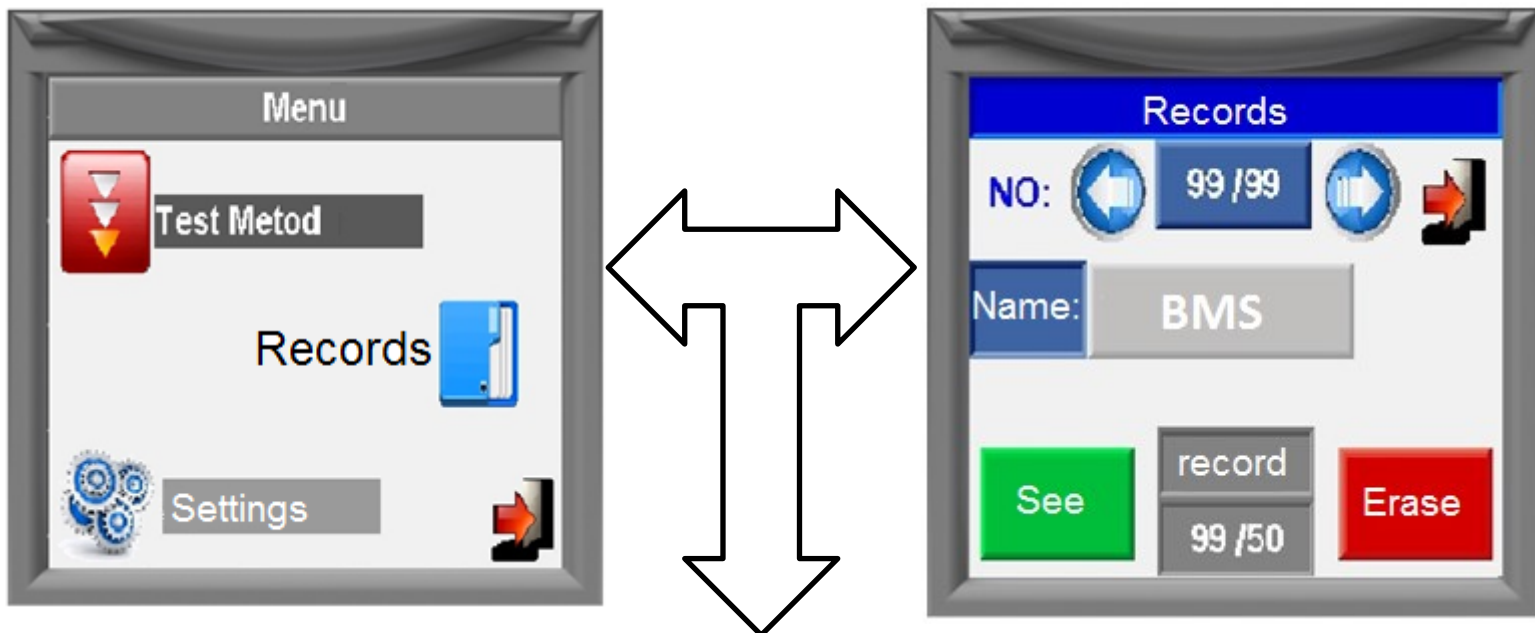

You can see the test records on the main menu, you can delete and transfer saved data's to the printer or computer.

12 Settings

Printer/PC, date / time average number of test time, factory setting, test the lower limit, upper limit, language can be entered using the function keys.



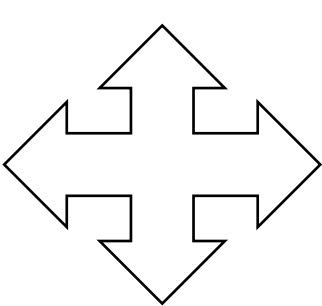

You can edit the following options from the Settings

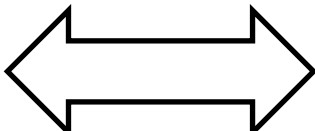
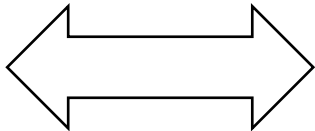
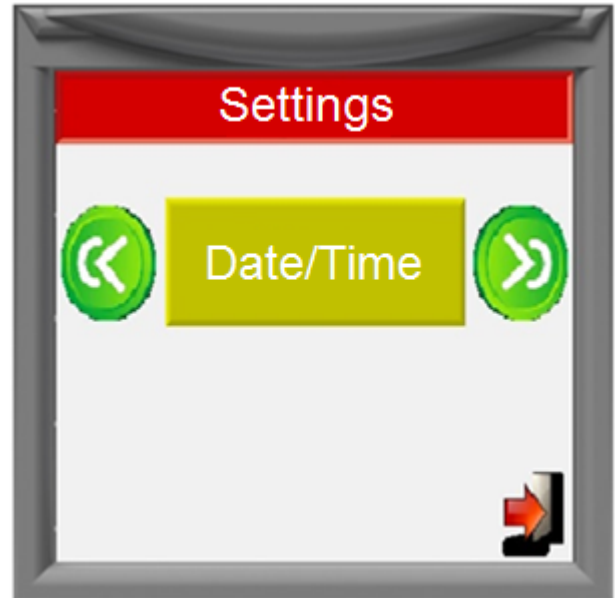
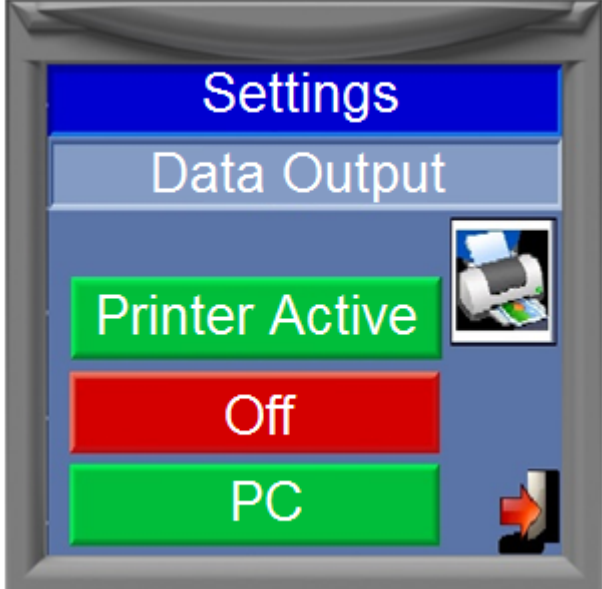

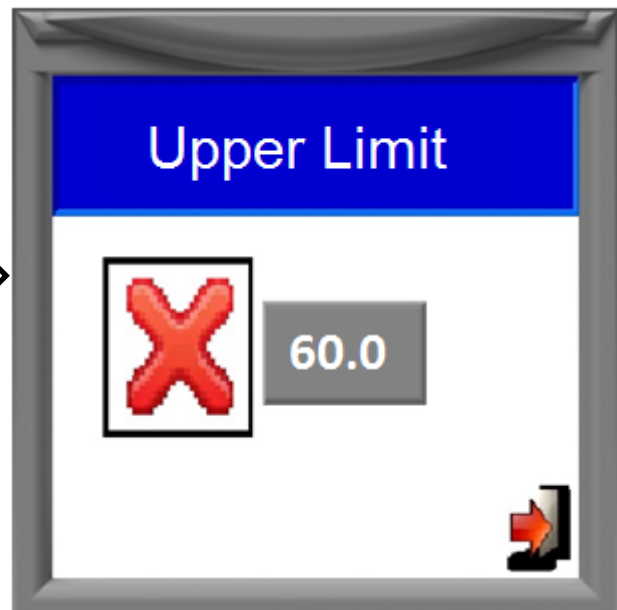
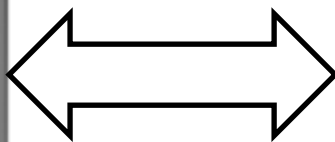
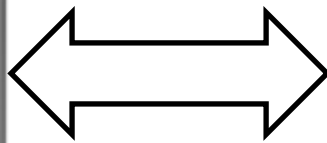
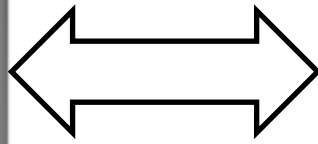

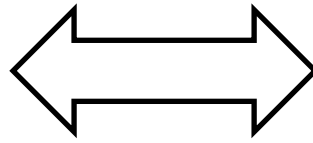
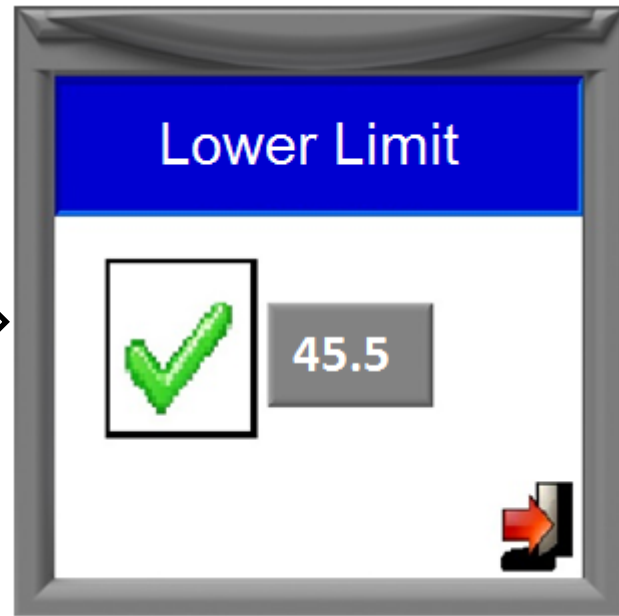
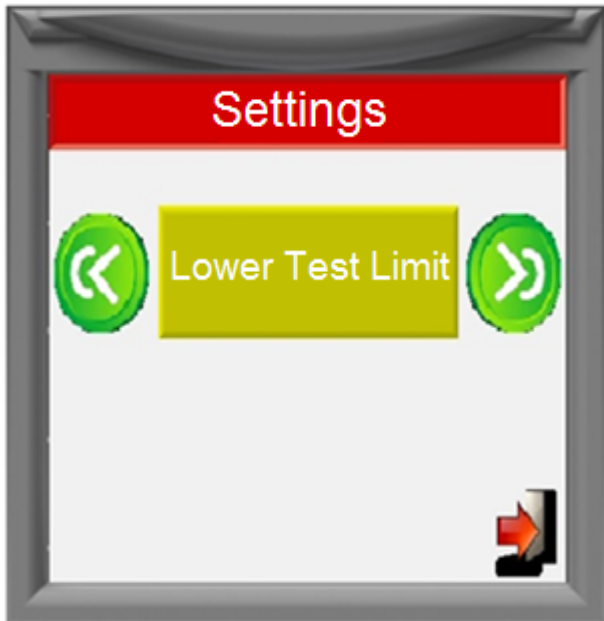

During the pre-load, if overload occurs or wrong application applied related messages shown.

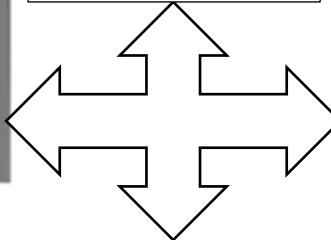
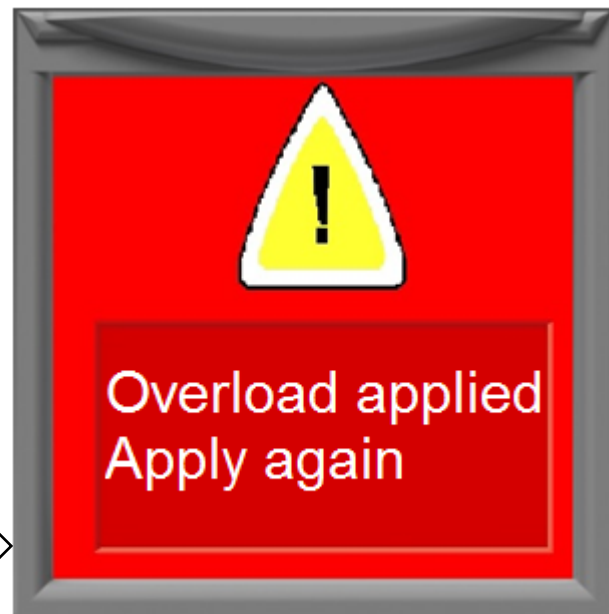

Do you want to delete
test memory

Yes
Delete

No
Exit

Each of the 100 data
capacity, 50 memory
zones available.
Total data capacity is
5.000

Records full

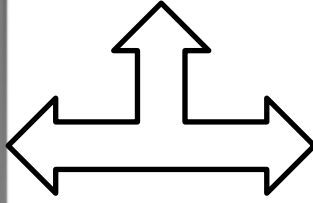

Name: **BMS**

No Test Test method Date Time

min

wt

maks

S.Sp

Goiter

99 /99

Zones in the
memory can easily
be registered &
you can examine
the results of tests

Print

1

2

3

4

5

6

Make:

Cita:

Min:

S.d.S

BMS

HRC **61.3**

TS Alloy

Hardness conversions

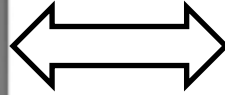

For Rockwell tests, you can choose radius of round parts

13 Calibration

Important Notice: During calibration, 2 point calibration system used. Therefore, for each hardness test calibration, uppest and lowest test blocks must be choosen according to test meethods. For example, for HRC method, uppest block value 62-65 HRC, lowest block value 22-25 HRC arasında can be choosen. Your equipment is calibrated under related EN norms. You do not need to calibrate the equipment again.

But, if required, calibration can be made using EN norms by expert persons under suitable conditions. In case of making mistakes during calibration, we recommend to go SETTINGS menu and use FACTORY SEETINGS fonction. Then, you can return original calibrated values.

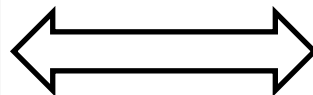

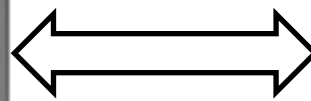
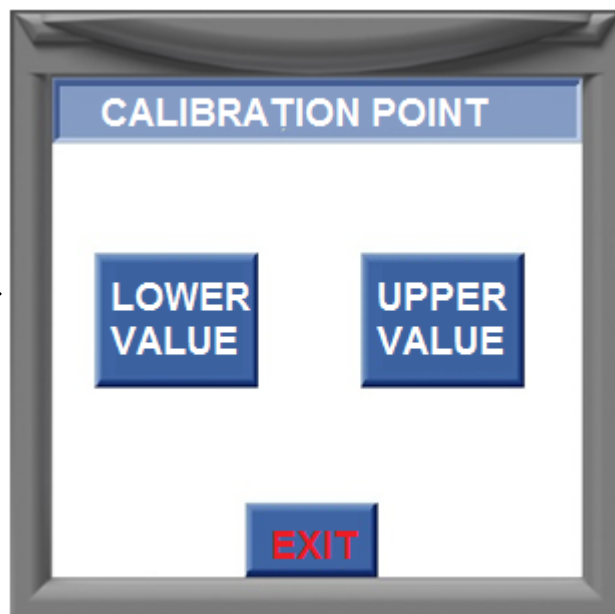
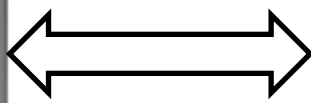

To save the calibration values as the factory settings registration password should be requested from our company.
 NOTE: If wrong calibration is made, factory setting can be achieved again using setting menu.